

SONY[®]

Sound Bar

Operating Instructions

HT-CT370/HT-CT770

WARNING

Do not install the appliance in a confined space, such as a bookcase or built-in cabinet.

To reduce the risk of fire, do not cover the ventilation opening of the appliance with newspapers, tablecloths, curtains, etc.
Do not expose the appliance to naked flame sources (for example, lighted candles).

To reduce the risk of fire or electric shock, do not expose this appliance to dripping or splashing, and do not place objects filled with liquids, such as vases, on the appliance.

The unit is not disconnected from the mains as long as it is connected to the AC outlet, even if the unit itself has been turned off.

As the main plug is used to disconnect the unit from the mains, connect the unit to an easily accessible AC outlet. Should you notice an abnormality in the unit, disconnect the main plug from the AC outlet immediately.

Do not expose batteries or appliances with battery-installed to excessive heat, such as sunshine and fire.

Indoor use only.

For the Bar Speaker

The nameplate is located on the bottom.

Recommended cables

Properly shielded and grounded cables and connectors must be used for connection to host computers and/or peripherals.

This equipment has been tested and found to comply with the limits set out in the EMC Directive using a connection cable shorter than 3 meters.

Notice for customers: the following information is only applicable to equipment sold in countries applying EU directives.

This product has been manufactured by or on behalf of Sony Corporation, 1-7-1 Konan Minato-ku Tokyo, 108-0075 Japan. Inquiries related to product compliance based on European Union legislation shall be addressed to the authorized representative, Sony Deutschland GmbH, Hedelfinger Strasse 61, 70327 Stuttgart, Germany. For any service or guarantee matters, please refer to the addresses provided in the separate service or guarantee documents.



Hereby, Sony Corp., declares that this equipment is in compliance with the essential requirements and other relevant provisions of Directive 1999/5/EC.

For details, please access the following URL:
<http://www.compliance.sony.de/>

Picture perfect sound

Sound Bar with wireless subwoofer - Bring your movie and music experience to life.



Disposal of Old Electrical & Electronic Equipment (Applicable in the European Union and other European countries with separate collection systems)

This symbol on the product or on its packaging indicates that this product shall not be treated as household waste. Instead it shall be handed over to the applicable collection point for the recycling of

electrical and electronic equipment. By ensuring this product is disposed of correctly, you will help prevent potential negative consequences for the environment and human health, which could otherwise be caused by inappropriate waste handling of this product. The recycling of materials will help to conserve natural resources. For more detailed information about recycling of this product, please contact your local Civic Office, your household waste disposal service or the shop where you purchased the product.

Europe Only



Disposal of waste batteries (applicable in the European Union and other European countries with separate collection systems)

Pb

This symbol on the battery or on the packaging indicates that the battery provided with this product shall not be treated as household waste.

On certain batteries this symbol might be used in combination with a chemical symbol. The chemical symbols for mercury (Hg) or lead (Pb) are added if the battery contains more than 0.0005% mercury or 0.004% lead.

By ensuring these batteries are disposed of correctly, you will help prevent potentially negative consequences for the environment and human health which could otherwise be caused by inappropriate waste handling of the battery. The recycling of the materials will help to conserve natural resources.

In case of products that for safety, performance or data integrity reasons require a permanent connection with an incorporated battery, this battery should be replaced by qualified service staff only.

To ensure that the battery will be treated properly, hand over the product at end-of-life to the applicable collection point for the recycling of electrical and electronic equipment.

For all other batteries, please view the section on how to remove the battery from the product safely. Hand the battery over to the applicable collection point for the recycling of waste batteries.

For more detailed information about recycling of this product or battery, please contact your local Civic Office, your household waste disposal service or the shop where you purchased the product.

Table of contents

Useful functions

Installing the Bar Speaker on a wall	5
Using the Control for HDMI function	7
Using "BRAVIA" Sync features	8
Controlling the system using a smartphone or tablet device (SongPal)	9
Adjusting the settings	11
Linking the system (LINK)	13

Miscellaneous

Precautions	14
BLUETOOTH wireless technology	16
Troubleshooting	17
Parts and controls	20
Specifications	26

Refer to the supplied Startup Guide for setup and basic operations.

Installing the Bar Speaker on a wall

You can install the Bar Speaker on a wall.

Notes

- Prepare screws (not supplied) that are suitable for the wall material and strength. As a plasterboard wall is especially fragile, attach the screws securely to two studs in the wall beam. Install the Bar Speaker horizontally, hung by screws in studs in a continuous flat section of the wall.
- Be sure to subcontract the installation to Sony dealers or licensed contractors and pay special attention to safety during the installation.
- Sony shall not be held responsible for accidents or damage caused by improper installation, insufficient wall strength, improper screw installation or natural calamity, etc.

- 1** Fix the supplied wall mounting brackets to the bracket fixing holes on the bottom of the Bar Speaker with the supplied screws so that the surface of each wall mounting bracket is as shown in the illustration.

Fix the two wall mounting brackets to the left and right fixing holes on the bottom of the Bar Speaker.

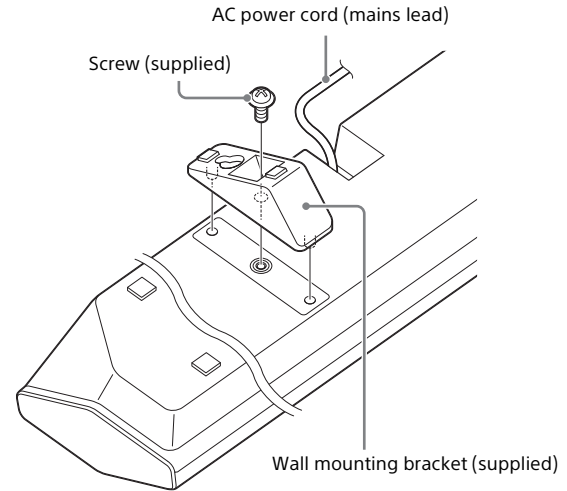

- 2 Prepare screws (not supplied) that are suitable for the holes on the back of the wall mounting brackets.**

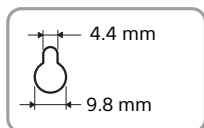
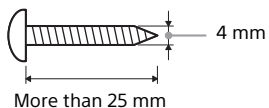

Hole on the wall mounting bracket

- 3 Fasten the screws to two studs in the wall.**

The screws should protrude 6 to 7 mm.

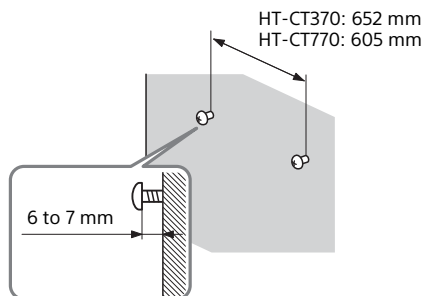

- 4 Hang the wall mounting brackets fixed on the Bar Speaker on the screws.**

Align the holes in the wall mounting brackets with the screws, then hang the Bar Speaker on the two screws.

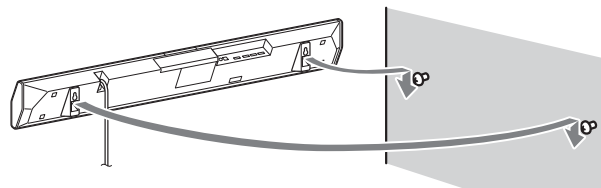

Tip

The Bar Speaker automatically detects whether it is mounted on a wall or positioned flat, and it optimizes the sound for its orientation.

Using the Control for HDMI function

By using the Control for HDMI function, and connecting equipment that is compatible with the Control for HDMI function via a High Speed HDMI cable, operation is simplified with the features below. The Control for HDMI function is enabled by setting "CTRL (Control for HDMI)" to "ON" (page 12). The default setting is "ON."

System Power Off

When you turn off the TV, the system and the connected equipment will turn off automatically.

System Audio Control

If you turn on the system while you are watching the TV, the TV sound will be output from the speakers of the system automatically. The volume of the system will be adjusted when you adjust the volume using the TV's remote control.

If the TV sound was output from the speakers of the system the last time you watched the TV, the system will be turned on automatically when you turn on the TV again.

Audio Return Channel (ARC)

If the TV is compatible with the Audio Return Channel (ARC) technology, a High Speed HDMI cable connection will also allow sending digital audio signals from the TV to the system. You do not need to make a separate audio connection for listening to TV sound from the system.

The ARC function is enabled by setting "ARC (Audio return channel)" to "ON" (page 12). The default setting is "ON."

One-Touch Play

When you activate the equipment (Blu-ray Disc™ player, "PlayStation®4," etc.) connected to the system with a High Speed HDMI cable, the connected TV is turned on automatically and the input signal of the system is switched to the appropriate HDMI input.

Notes

- The above features may not operate with certain equipment.
- Depending on the settings of the connected equipment, the Control for HDMI function may not work correctly. Refer to the operating instructions of the equipment.

Using "BRAVIA" Sync features

The original Sony functions listed below can also be used with products that are compatible with "BRAVIA" Sync.

Power save

If a "BRAVIA" Sync-compatible TV is connected to the system, the power consumption will be reduced in standby mode by stopping HDMI signal transmission when the TV is turned off with the pass-through function* of the system set to "AUTO" (page 12).

The default setting is "AUTO."

If any TV other than "BRAVIA" is connected, set the item to "ON" (page 12).

* The pass-through function for HDMI signals is used to output the signals from the HDMI OUT jack of this system even if it is in standby mode.

Notes on HDMI connections

- Use a High Speed HDMI cable. If you use a Standard HDMI cable, 1080p, Deep Color, 3D, and 4K images may not be displayed properly.
- Use an HDMI-authorized cable.
Use a Sony High Speed HDMI cable with the Cable Type Logo.
- We do not recommend using an HDMI-DVI conversion cable.
- Check the setup of the connected equipment if an image is poor or the sound does not come out of the equipment connected via the HDMI cable.
- Audio signals (sampling frequency, bit length, etc.) transmitted from an HDMI jack may be suppressed by the connected equipment.
- Sound may be interrupted when the sampling frequency or the number of channels of audio output signals from the playback equipment is switched.

- If the connected equipment is not compatible with copyright-protection technology (HDCP), the image and/or the sound from the HDMI OUT jack of this system may be distorted or may not be output. In such a case, check the specifications of the connected equipment.
- When "TV" is selected as the input source of the system, video signals via one of the HDMI IN 1/2/3 jacks selected last time are output from the HDMI OUT jack.
- This system supports Deep Color, "x.v.Colour," 3D, and 4K transmission.
- To enjoy 3D images, connect a 3D-compatible TV and video equipment (Blu-ray Disc player, "PlayStation®4," etc.) to the system using High Speed HDMI cables, put on 3D glasses, and then play back a 3D-compatible Blu-ray Disc, etc.
- To enjoy 4K images, the TV and players that are connected to the system must be compatible with 4K images.

Controlling the system using a smartphone or tablet device (SongPal)

"SongPal" is the application to operate the system with your smartphone or tablet, etc.
"SongPal" is available from either Google Play™ or App Store.
This function is enabled by setting "BT PWR (BLUETOOTH power)" to "ON" (page 12). The default setting is "ON."

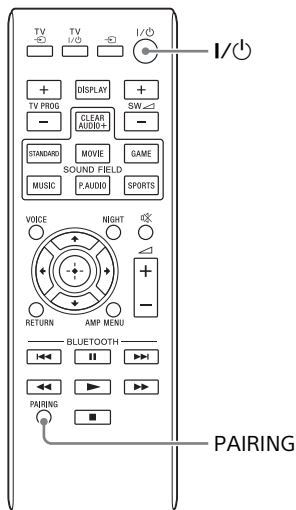

When using an Android™ device

- 1 Press the I/O (on/standby) button on the remote control.**
The display of the Bar Speaker lights.
- 2 Search for "SongPal" with the Android device and download that application.**
- 3 Run "SongPal" then follow the on-screen instructions.**
- 4 After the BLUETOOTH connection display appears on the Android device, press the PAIRING button on the remote control.**
The lamp (blue) flashes quickly during BLUETOOTH pairing.
- 5 Select "SONY:HT-CT370" or "SONY:HT-CT770" from the BLUETOOTH device list of the Android device.**
When the connection has been established, the lamp (blue) of the Bar Speaker lights.
- 6 Operate the system with the display of the connected Android device.**

One-Touch connection using the Android device with the NFC function built-in (NFC)

- 1 Perform steps 1 to 3 of “When using an Android device.”
- 2 After the **BLUETOOTH** connection display appears on the Android device, touch the Android device with the **N** mark of the Bar Speaker.

When the connection has been established, the lamp (blue) of the Bar Speaker lights.

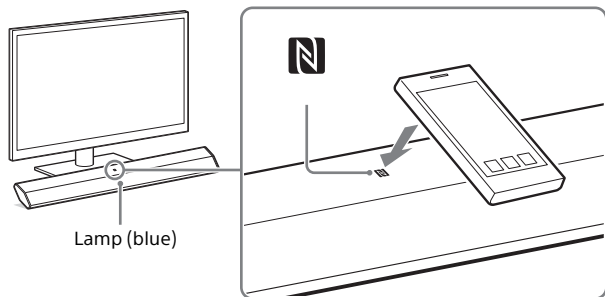

- 3 Operate the system with the display of the Android device.

When using an iPhone/iPod touch

- 1 Press the **I/⏻** (on/standby) button on the remote control.
The display of the Bar Speaker lights.
- 2 Press the **PAIRING** button on the remote control.
The lamp (blue) of the Bar Speaker flashes quickly during BLUETOOTH pairing.
- 3 Set the iPhone/iPod touch to pairing mode and select “SONY:HT-CT370” or “SONY:HT-CT770” from the BLUETOOTH device list on the iPhone/iPod touch.
When the connection has been established, the lamp (blue) of the Bar Speaker lights.
- 4 Search for “SongPal” with the connected iPhone/iPod touch and download that application.
- 5 Run “SongPal” then operate the system with the display of the iPhone/iPod touch.

Adjusting the settings

You can set the following items with the AMP MENU button on the remote control. Your settings are retained even if you disconnect the AC power cord (mains lead).

- 1 Press the AMP MENU button on the remote control to display the amplifier menu window on the display of the Bar Speaker.
- 2 Select the desired setting, using the ← (return)/↑ ↓ (select)/→ (proceed) button, and press the ⊕ (enter) button.
- 3 Press the AMP MENU button to exit the amplifier menu window.

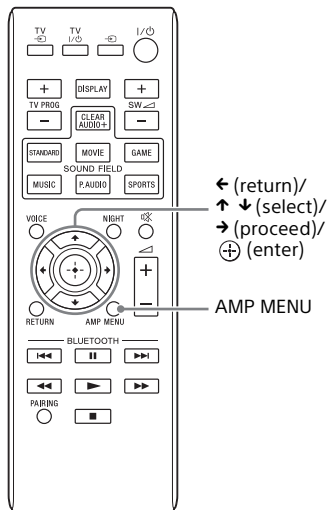

Menu		Function	Default
LEVEL	DRC (Dynamic range control)	You can enjoy Dolby Digital sound at low sound volumes. (ON/AUTO/OFF) ON: Compresses sound in accordance with the compression information contained in the content. AUTO: Automatically compresses sound encoded in Dolby TrueHD. OFF: Sound is not compressed.	AUTO
	TONE		
	BASS	Low sound is emphasized. The setting can be changed from -6 to +6 in units of 1.	0
	TREBLE	High sound is emphasized. The setting can be changed from -6 to +6 in units of 1.	0
AUDIO	SYNC (AV sync)	You can adjust the sound when the image and the sound are not in sync. (ON/OFF)	OFF
	DUAL (Dual mono)	You can enjoy multiplex broadcast sound of Dolby Digital audio. (M/S (main and sub channels)/MAIN (main channel)/SUB (sub channel))	MAIN
	AAV (Advanced auto volume)	Reduces the volume discrepancies between different programs or between programs and commercials. (ON/OFF)	OFF
	EFFECT (Sound effect)	ON: The sound of the selected sound field is played. It is recommended to use this setting. OFF: The input source is down-mixed for 2 channels. Note: When "EFFECT (Sound effect)" is set to "OFF," "EFFECT (Sound effect)" is automatically set to "ON" when you change the SOUND FIELD setting.	ON

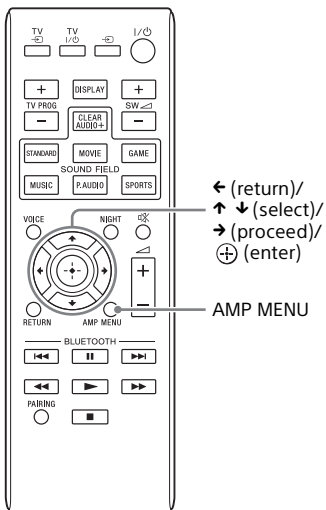

Menu	Function	Default	
HDMI	CTRL (Control for HDMI)	To switch the Control for HDMI function on or off. (ON/OFF) Refer to "Using the Control for HDMI function" (page 7) for details.	ON
	P. THRU (Pass through)	To set the power saving mode of the pass-through function for HDMI signals. (AUTO/ON) AUTO: Outputs signals from the HDMI OUT jack of the system in standby mode according to the status of the TV. This setting saves power in standby mode compared with the "ON" setting. ON: Always outputs signals from the HDMI OUT jack in standby mode. If any TV other than "BRAVIA" is connected, use the system with the "ON" setting. Note: This item appears only when "CTRL (Control for HDMI)" is set to "ON."	AUTO
	ARC (Audio return channel)	To listen to digital sound from a TV compatible with the Audio Return Channel (ARC) technology that is connected using a High Speed HDMI cable. (ON/OFF) Note: This item appears only when "CTRL (Control for HDMI)" is set to "ON."	ON
SET BT	BT PWR (BLUETOOTH power)	To switch the BLUETOOTH function of this system on and off. (ON/OFF) Note: If you change the setting to "OFF," the BLUETOOTH function and the NFC function become disabled.	ON
	BT.STBY (BLUETOOTH standby)	When the system has pairing information, the system is in the BLUETOOTH standby mode even when it is turned off. (ON/OFF)	ON
	AAC (Advanced audio coding)	To set whether or not the system will use AAC via BLUETOOTH. (ON/OFF) Note: If you change the setting when the system is connected with a BLUETOOTH device, the system will be disconnected from the device.	ON
SYSTEM	A. STBY (Auto standby)	To switch the AUTO POWER OFF function on or off. (ON/OFF) The system turns off automatically when no operation has been made within a certain period (about 20 minutes) and the system is not receiving an input signal.	ON
	VER (Version)	To display the current firmware version.	-
	SYS.RST (System cold reset)	To reset menus and settings (sound fields, etc.) of the system to the initial status when it does not work properly. Refer to "Troubleshooting" (page 19) for details.	-
WS	LINK	To link the wireless sound system again (page 13).	-
	RF CHK	To check whether the wireless sound system of the system can communicate or not. (OK/NG)	-

Linking the system (LINK)

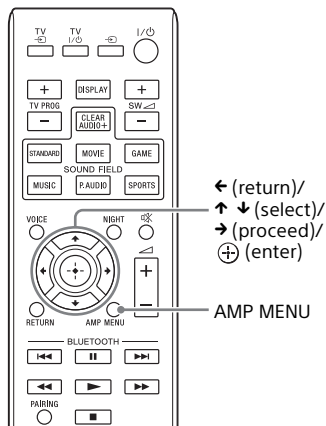

On/standby lamp

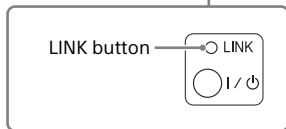
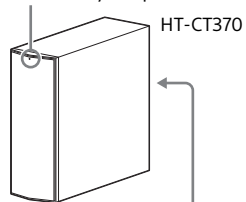

On/standby lamp

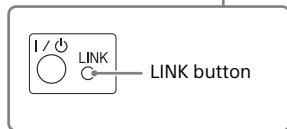
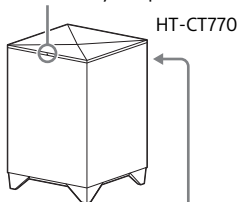

Set up the wireless subwoofer connection again.

- 1** Press the **AMP MENU** button on the remote control.
- 2** Select **"WS"** with the **↑ ↓ (select)** button then press the **⊕ (enter)** or **→ (proceed)** button.
- 3** Select **"LINK"** with the **↑ ↓ (select)** button then press the **⊕ (enter)** or **→ (proceed)** button.
- 4** When **"START"** appears on the display of the **Bar Speaker**, press the **⊕ (enter)** button.
 "SEARCH" appears, and the Bar Speaker searches for equipment that can be used with Link. Proceed to the next step within 1 minute.
 To quit the Link function during a search for equipment, press the **← (return)** button.
- 5** Press the **LINK** button on the subwoofer with the point of a pen, etc.
 The on/standby lamp on the subwoofer lights in green. "OK" appears on the display of the Bar Speaker.
 If "FAILED" appears, check to ensure the subwoofer is turned on and perform the process again from step 1.
- 6** Press the **AMP MENU** button.
 The amplifier menu turns off.

Precautions

On safety

- Should any solid object or liquid fall into the system, unplug the system and have it checked by qualified personnel before operating it any further.
- Do not climb on the Bar Speaker and subwoofer, as you may fall down and injure yourself, or system damage may result.

On power sources

- Before operating the system, check that the operating voltage is identical to your local power supply. The operating voltage is indicated on the nameplate at the bottom of the Bar Speaker.
- If you are not going to use the system for a long time, be sure to disconnect the system from the wall outlet (mains). To disconnect the AC power cord (mains lead), grasp the plug itself; never pull the cord.
- One blade of the plug is wider than the other for the purpose of safety and will fit into the wall outlet (mains) only one way. If you are unable to insert the plug fully into the outlet, contact your dealer.
- AC power cord (mains lead) must be changed only at a qualified service shop.

On heat buildup

Although the system heats up during operation, this is not a malfunction. If you continuously use this system at high volume, the system temperature at the rear and bottom rises considerably. To avoid burning yourself, do not touch the system.

On placement

- Place the system in a location with adequate ventilation to prevent heat buildup and prolong the life of the system.
- Do not place the system near heat sources or in a place subject to direct sunlight, excessive dust, or mechanical shock.

- Do not place anything at the rear of the Bar Speaker and subwoofer that might block the ventilation holes and cause malfunctions.
- If the system is being used in combination with a TV, VCR, or tape deck, noise may result and picture quality may suffer. In such a case, place the system away from the TV, VCR, or tape deck.
- Use caution when placing the system on a surface that has been specially treated (with wax, oil, polish, etc.), as staining or discoloration of the surface may result.
- Take care to avoid any possible injury from the corners of the Bar Speaker and subwoofer.

On operation

Before connecting other equipment, be sure to turn off and unplug the system.

If you encounter color irregularity on a nearby TV screen

Color irregularities may be observed on certain types of TV sets.

If color irregularity is observed...

Turn off the TV set, then turn it on again after 15 to 30 minutes.

If color irregularity is observed again...

Place the system further away from the TV set.

On cleaning

Clean the system with a soft, dry cloth. Do not use any type of abrasive pad, scouring powder, or solvent such as alcohol or benzene.

If you have any question or problem concerning your system, please consult your nearest Sony dealer.

Copyrights

This system incorporates Dolby* Digital and the DTS** Digital Surround System.

- * Manufactured under license from Dolby Laboratories. Dolby, and the double-D symbol are trademarks of Dolby Laboratories.
- ** Manufactured under license under U.S. Patent Nos: 5,956,674; 5,974,380; 6,226,616; 6,487,535; 7,212,872; 7,333,929; 7,392,195; 7,272,567 & other U.S. and worldwide patents issued & pending. DTS-HD, the Symbol, & DTS-HD and the Symbol together are registered trademarks of DTS, Inc. Product includes software. © DTS, Inc. All Rights Reserved.

The BLUETOOTH® word mark and logos are registered trademarks owned by Bluetooth SIG, Inc. and any use of such marks by Sony Corporation is under license.

This system incorporates High-Definition Multimedia Interface (HDMI™) technology.

The terms HDMI and HDMI High-Definition Multimedia Interface, and the HDMI Logo are trademarks or registered trademarks of HDMI Licensing LLC in the United States and other countries.

“BRAVIA” logo is a trademark of Sony Corporation.

“DSEE” is a trademark of Sony Corporation.

“x.v.Colour” and “x.v.Colour” logo are trademarks of Sony Corporation.

“PlayStation®” is a registered trademark of Sony Computer Entertainment Inc.

The N Mark is a trademark or registered trademark of NFC Forum, Inc. in the United States and in other countries.

Android and Google Play are trademarks of Google Inc.

“ClearAudio+” is a trademark of Sony Corporation.

Apple, the Apple logo, iPhone, iPod, and iPod touch are trademarks of Apple Inc., registered in the U.S. and other countries. App Store is a service mark of Apple Inc.



“Made for iPod,” and “Made for iPhone” mean that an electronic accessory has been designed to connect specifically to iPod or iPhone, respectively, and has been certified by the developer to meet Apple performance standards. Apple is not responsible for the operation of this device or its compliance with safety and regulatory standards. Please note that the use of this accessory with iPod or iPhone may affect wireless performance.

Made for iPod/iPhone models

The compatible iPod/iPhone models are as follows. Update your iPod/iPhone with the latest software before using with the system.

BLUETOOTH technology works with:

- iPhone
 - iPhone 5s/iPhone 5c/iPhone 5/iPhone 4s/iPhone 4/iPhone 3GS
- iPod touch
 - iPod touch (5th generation)/iPod touch (4th generation)

Other trademarks and trade names are those of their respective owners.

BLUETOOTH wireless technology

Supported BLUETOOTH version and profiles

Profile refers to a standard set of functions for various BLUETOOTH product features. Refer to “Specifications” (page 26) for the BLUETOOTH version and profiles supported by this system.

Notes

- To use the BLUETOOTH function, the BLUETOOTH device to be connected must support the same profile as this system. Even if the device supports the same profile, the functions may differ because of the specifications of the BLUETOOTH device.
- Audio playback on this system may be delayed from that on the BLUETOOTH device because of the characteristics of the BLUETOOTH wireless technology.

Effective communication range

BLUETOOTH devices should be used within approximately 10 meters (unobstructed distance) of each other. The effective communication range may become shorter under the following conditions;

- When a person, metal object, wall or other obstruction is between devices with a BLUETOOTH connection
- Locations where a wireless LAN is installed
- Around microwave ovens that are in use
- Locations where other electromagnetic waves are generated

Effects of other devices

BLUETOOTH devices and wireless LAN (IEEE 802.11b/g) equipment use the same frequency band (2.4 GHz). When using your BLUETOOTH device near a device with wireless LAN capability, electromagnetic interference may occur.

This could result in lower data-transfer rates, noise, or inability to connect. If this happens, try the following remedies:

- Connect this system and BLUETOOTH mobile phone or BLUETOOTH device when you are at least 10 meters away from the wireless LAN equipment.

- Turn off the power to the wireless LAN equipment when using your BLUETOOTH device within 10 meters.

Effects on other devices

The radio waves broadcast by this system may interfere with the operation of some medical devices. Since this interference may result in malfunction, always turn off the power to this system, BLUETOOTH mobile phone and BLUETOOTH device in the following locations:

- In hospitals, on trains or airplanes, at gas stations, and any place where flammable gasses may be present
- Near automatic doors or fire alarms

Notes

- This system supports security functions that comply with the BLUETOOTH specification as a means of ensuring security during communication using BLUETOOTH technology. However, this security may be insufficient, depending on the settings and other factors. So always be careful when performing communication using BLUETOOTH technology.
- Sony shall not be held liable in any way for damages or other loss resulting from information leaks during communication using BLUETOOTH technology.
- BLUETOOTH communication is not necessarily guaranteed with all BLUETOOTH devices that have the same profile as this system.
- BLUETOOTH devices connected with this system must comply with the BLUETOOTH specification prescribed by the Bluetooth SIG, Inc., and must be certified to comply. However, even when a device complies with the BLUETOOTH specification, there may be cases where the characteristics or specifications of the BLUETOOTH device make it impossible to connect or may result in different control methods, display, or operation.
- Noise may occur or the audio may cut off, depending on the BLUETOOTH device connected with this system, the communications environment, or surrounding conditions.

Troubleshooting

If you experience any of the following difficulties while using the system, use this troubleshooting guide to help remedy the problem before requesting repairs. Should any problem persist, consult your nearest Sony dealer.

Be sure to bring both your Bar Speaker and subwoofer, even if it seems as though only one has a problem, when you request to repair.

POWER

The system does not power up.

→ Check that the AC power cord (mains lead) is connected securely.

The system is turned off automatically.

→ The "A. STBY" function is working. Set "A. STBY (Auto standby)" to "OFF" (page 12).

SOUND

No TV sound is output from the system.

→ Repeatedly press the  button on the remote control to display "TV" in the display (refer to "Listening to the audio of the TV" in the supplied Startup Guide).

→ Check the connection of the HDMI cable, optical digital cable, or audio cable that is connected to the system and the TV (refer to "Connection" in the supplied Startup Guide).

→ Check the sound output of the TV. Refer to the operating instructions of the TV for the TV settings.

→ Increase the volume on the TV or cancel muting.

→ When a TV compatible with the Audio Return Channel (ARC) technology is connected with an HDMI cable, make sure the cable is connected to the HDMI input (ARC) terminal of the TV (refer to "Connection" in the supplied Startup Guide).

→ If the TV is not compatible with the Audio Return Channel (ARC) technology, connect the optical digital cable in addition to the HDMI cable in order to output sound (refer to "Connection" in the supplied Startup Guide).

The sound is output from both the system and the TV.



→ Turn off the sound of the system or the TV.

The TV sound from this system lags behind the image.

→ Set "SYNC (AV sync)" to "OFF" if it is set to "ON" (page 11).

No sound or only a very low-level sound of the equipment connected to the Bar Speaker is heard from the Bar Speaker.

→ Press the  + button on the remote control and check the volume level (refer to "Parts and controls" (page 20)).

→ Press the  or  + button on the remote control to cancel the muting function (refer to "Parts and controls" (page 24)).

→ Make sure the input source is selected correctly. You should try other input sources by pressing the  button on the remote control several times (refer to "Listening to the sound" in the supplied Startup Guide).

→ Check that all the cables and cords of the system and the connected equipment are firmly inserted.

No sound or only a very low-level sound is heard from the subwoofer.

→ Press the SW  + button on the remote control to increase the subwoofer volume (refer to "Parts and controls" (page 24)).

→ Make sure that the on/standby lamp on the subwoofer is lit in green. If not, refer to "No sound is heard from the subwoofer." in "WIRELESS SOUND" (page 18).

→ A subwoofer is for reproducing bass sound. In the case of input sources that contain very little bass sound components (i.e., a TV broadcast), the sound from the subwoofer may be difficult to hear.

→ When you play content compatible with copyright protection technology (HDCP), it is not output from the subwoofer.

The surround effect cannot be obtained.

→ Depending on the input signal and the sound field setting, surround sound processing may not work effectively. The surround effect may be subtle, depending on the program or disc.

→ To play multi channel audio, check the digital audio output setting on the device connected to the system. For details, refer to the operating instructions supplied with the connected equipment.

continued

BLUETOOTH

BLUETOOTH connection cannot be completed.

- Make sure that the lamp (blue) of the Bar Speaker is lit (refer to “Listening to the sound from BLUETOOTH devices” in the supplied Startup Guide).

System status	Lamp (blue) status
During BLUETOOTH pairing	Flashes quickly
The system is attempting to connect with a BLUETOOTH device	Flashes
The system has established connection with a BLUETOOTH device	Lit
The system is in BLUETOOTH standby mode (when the system is off)	Unlit

- Make sure the BLUETOOTH device to be connected is turned on and the BLUETOOTH function is enabled.
- Bring this system and the BLUETOOTH device closer together.
- Pair this system and the BLUETOOTH device again. You may need to cancel the pairing with this system using your BLUETOOTH device first.

Pairing cannot be achieved.

- Bring this system and the BLUETOOTH device closer together (refer to “Listening to the sound from BLUETOOTH devices” in the supplied Startup Guide).
- Make sure this system is not receiving interference from a wireless LAN equipment, other 2.4 GHz wireless devices, or a microwave oven. If a device that generates electromagnetic radiation is nearby, move the device away from this system.

No sound is output from the connected BLUETOOTH device.

- Make sure that the lamp (blue) of the Bar Speaker is lit (refer to “Listening to the sound from BLUETOOTH devices” in the supplied Startup Guide).
- Bring this system and the BLUETOOTH device closer together.
- If a device that generates electromagnetic radiation, such as a wireless LAN equipment, other BLUETOOTH devices, or a microwave oven is nearby, move the device away from this system.

- Remove any obstacle between this system and the BLUETOOTH device or move this system away from the obstacle.
- Reposition the connected BLUETOOTH device.
- Try changing the wireless frequency of the Wi-Fi router, computer, etc., to the 5 GHz band.
- Increase the volume on the connected BLUETOOTH device.

The sound is not in sync with the image.

- When you are watching movies, you may hear the sound with a slight delay from the image.

WIRELESS SOUND

No sound is heard from the subwoofer.

- Check that the AC power cord (mains lead) of the subwoofer is connected properly. (Refer to “Turning on the system” in the supplied Startup Guide.)
- The on/standby lamp does not light.
 - Check that the AC power cord (mains lead) of the subwoofer is connected properly.
 - Press the I/⏻ (on/standby) button of the subwoofer to turn on the power.
- The on/standby lamp flashes slowly in green or lights in red.
 - Move the subwoofer to a location near the Bar Speaker so that the on/standby lamp lights in green.
 - Follow the steps in “Linking the system (LINK)” (page 13).
 - Check the communication status of the wireless sound system with the “RF CHK” of the amplifier menu (page 12).
- The on/standby lamp flashes quickly in green.
 - Consult your nearest Sony dealer.
- The on/standby lamp flashes in red.
 - Press the I/⏻ (on/standby) button of the subwoofer to turn off the power and check whether the ventilation opening of the subwoofer is blocked or not.
- The subwoofer is designed for playback of bass sound. When the input source does not contain much of bass sound, as is the case with most TV programs, the bass sound may not be audible.
- Press the SW ◀ + button on the remote control to increase the volume of the subwoofer (refer to “Parts and controls” (page 24)).

Sound skips or has noise.

- If there is a device nearby that generates electromagnetic waves like a wireless LAN or an electronic oven in use, locate the system apart from it.
- If there is an obstacle between the Bar Speaker and the subwoofer, move or remove it.
- Locate the Bar Speaker and the subwoofer as close as possible.
- Switch the wireless LAN frequency of any nearby Wi-Fi router or personal computer to 5-GHz range.

REMOTE CONTROL**The remote control of this system does not function.**

- Point the remote control at the remote control sensor on the Bar Speaker (refer to "Parts and controls" (page 24)).
- Remove any obstacles in the path between the remote control and the system.
- Replace both batteries in the remote control with new ones, if they are weak.
- Make sure you are pressing the correct button on the remote control.

OTHERS**The Control for HDMI function does not work properly.**

- Check the HDMI connection (refer to "Connection" in the supplied Startup Guide).
- Set up the Control for HDMI function on the TV. Refer to the operating instructions supplied with the TV for TV setting.
- Make sure that any equipment connected is compatible with "BRAVIA" Sync.
- Check the Control for HDMI settings on the connected equipment. Refer to the operating instructions supplied with the connected equipment.
- If you connect/disconnect the AC power cord (mains lead), wait more than 15 seconds before operating the system.
- If you connect the audio output of video equipment with the system, using a cable other than an HDMI cable, no sound may be output because of "BRAVIA" Sync. In such a case, set "CTRL

(Control for HDMI)" to "OFF" (page 12) or connect the cable from the audio output jack of the video equipment directly to the TV.

"PRTECT (protect)" appears on the display of the Bar Speaker.

- Press the I/⏻ (on/standby) button to turn off the system. After the indicator disappears, disconnect the AC power cord (mains lead) then check that nothing is blocking the ventilation holes of the system.

Sensors of the TV do not work properly.

- The Bar Speaker may block some sensors (such as the brightness sensor) and the remote control receiver of your TV, or the "emitter for 3D glasses (infrared transmission)" of a 3D TV that supports the infrared 3D glass system. Move the Bar Speaker away from the TV within a range that allow those parts to operate properly. For the locations of the sensors and remote control receiver, refer to the operating instructions supplied with the TV.

RESET

If the system still does not operate properly, reset the system as follows:

- 1 Press the I/⏻ (on/standby) button on the remote control to turn the Bar Speaker on.**
- 2 Press the AMP MENU button on the remote control.**
- 3 Press the ↑ ↓ (select) button repeatedly until "SYSTEM" appears, then press the ⊕ (enter) button.**
- 4 Press the ↑ ↓ (select) button repeatedly until "SYS.RST" appears, then press the ⊕ (enter) button (page 12).**
- 5 Press the ⊕ (enter) button after displaying "START."** "RESET" appears on the display, and the settings of the menu and sound fields, etc. return to their initial statuses.
- 6 Disconnect the AC power cord (mains lead).**

Parts and controls

HT-CT370

Bar Speaker

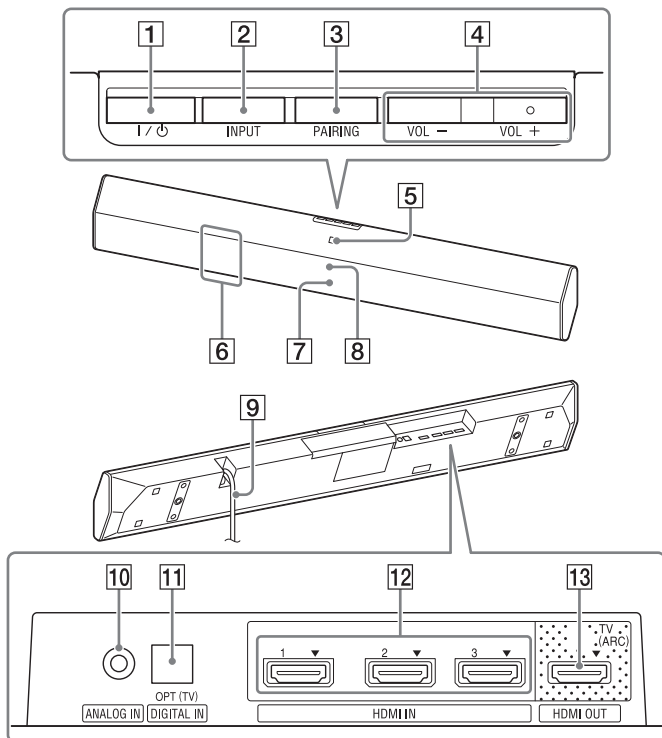

Front/Top

- 1 I/⏻ (on/standby) button
- 2 INPUT button
- 3 PAIRING button
- 4 VOL (volume) +/- buttons
- 5 N mark
When using the NFC function, touch your NFC device to the mark.
- 6 Remote control sensor
- 7 Lamp
 - White: when the display of the Bar Speaker is turned off.
 - Blue: BLUETOOTH mode (page 18)
- 8 Display

Rear/Bottom

- 9 AC power cord (mains lead)
- 10 ANALOG IN jack
- 11 DIGITAL IN (OPT (TV)) jack
- 12 HDMI IN 1/2/3 jacks
- 13 HDMI OUT (TV (ARC)) jack

Subwoofer

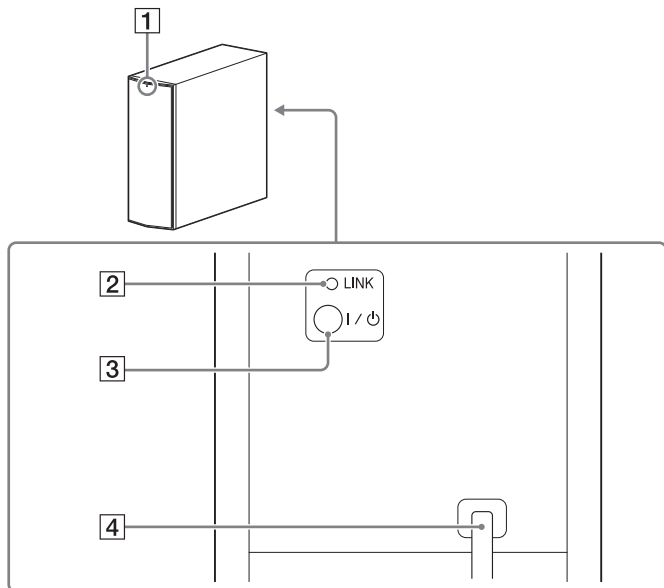

- 1 On/standby lamp
- 2 LINK button
- 3 I/⏻ (on/standby) button
- 4 AC power cord (mains lead)

HT-CT770

Bar Speaker

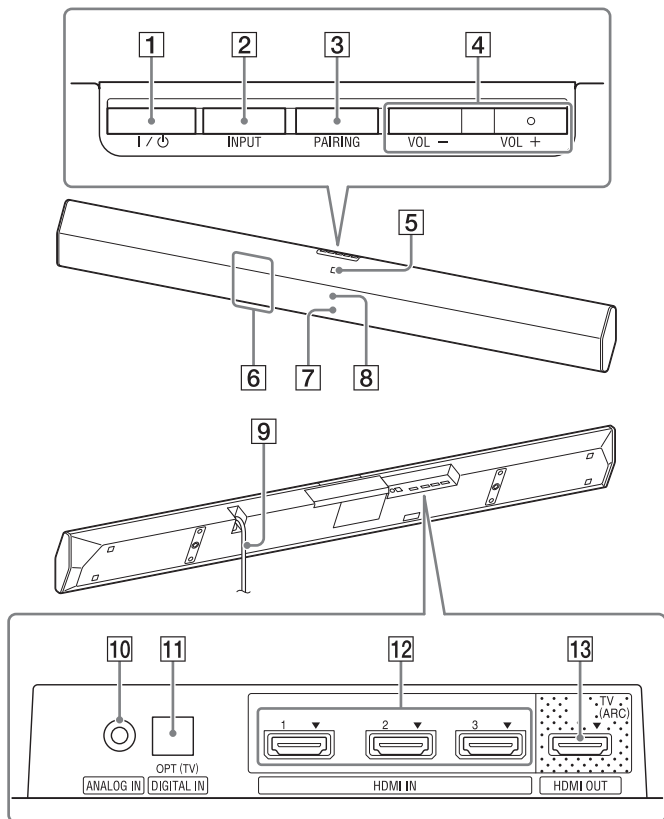

Front/Top

- 1 I/⏻ (on/standby) button
- 2 INPUT button
- 3 PAIRING button
- 4 VOL (volume) +/- buttons
- 5 N mark
When using the NFC function, touch your NFC device to the mark.
- 6 Remote control sensor
- 7 Lamp
 - White: when the display of the Bar Speaker is turned off.
 - Blue: BLUETOOTH mode (page 18)
- 8 Display

Rear/Bottom

- 9 AC power cord (mains lead)
- 10 ANALOG IN jack
- 11 DIGITAL IN (OPT TV) jack
- 12 HDMI IN 1/2/3 jacks
- 13 HDMI OUT (TV (ARC)) jack

Subwoofer

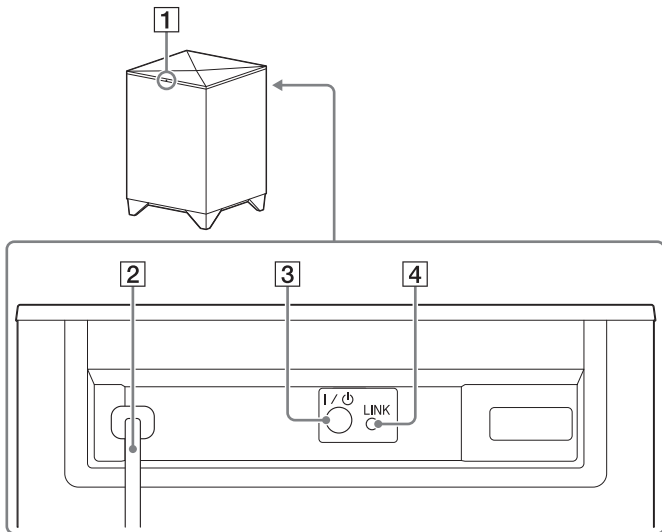

- 1 On/standby lamp
- 2 AC power cord (mains lead)
- 3 I/⏻ (on/standby) button
- 4 LINK button

Remote control

The supplied remote control can control the system and the connected devices. Some devices may not be controlled by it. In such a case, use the remote control of the device.

Note

Operate the remote control by aiming it at the remote control sensor of the Bar Speaker.

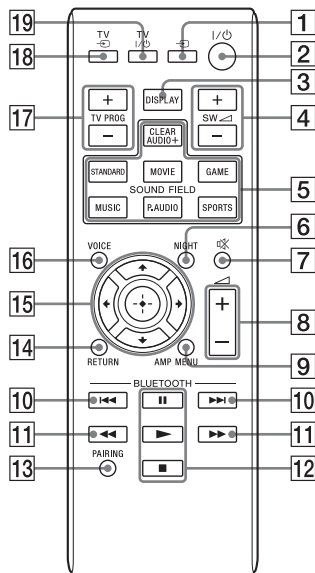

Operation of the system

- 1 **↻ (input) button**
- 2 **I/O (on/standby) button**
- 3 **DISPLAY button**
To switch the brightness (Bright/Dark/Off) of the display of the Bar Speaker.
 - When the display brightness is set to "Off," the display is turned off after the display shows operation status for several seconds.
 - When switched from "Off" to "Bright," the display shows the audio stream information.
- 4 **SW \sphericalangle (subwoofer volume) +/- buttons**
- 5 **SOUND FIELD buttons*1**
- 6 **NIGHT (night mode) button*1**
- 7 **⊗ (muting) button**
- 8 **\sphericalangle (volume) +*2/- buttons**
- 9 **AMP MENU button**
- 13 **PAIRING button**
- 14 **RETURN button**
- 15 **← (return)/↑ (select)/↓ (proceed)/⊕ (enter) buttons**
Press the ←, ↑, ↓, or → button to select a setting then press the ⊕ button to register the setting.
- 16 **VOICE button*1**

Operation of the TV

- 17 **TV PROG (program) +/- buttons**
To change the channel.
- 18 **TV ↻ (input) button**
To switch the input in the TV.
- 19 **TV I/O (on/standby) button**
To turn on and off a TV that can be controlled by the remote control of the system.

Operation of the BLUETOOTH device

10 ◀◀/▶▶ buttons

To skip a track.

11 ◀◀/▶▶ buttons

To fast reverse or to fast-forward the music when pressed during playback.

12 Playback control buttons

▶*2 (playback)/⏸ (pause)/■ (stop)

To start, pause or stop the playback. To restart playback during a pause, press the ⏸ button again.

Note

These are the basic operation examples. There may be a device that may not be operated or may work differently.

*1 Refer to “Enjoying the sound effects” in the supplied Startup Guide.

*2 The ▶ (playback) and ⏵ (volume) + buttons each have a tactile dot. Use it as a guide during operation.

Setting the manufacturer of the TV

- 1 Press the button corresponding to the manufacturer while holding the TV I/⏻ (on/standby) button on the remote control of the system pressed.

Manufacturer	Button
SONY	[17] TV PROG +
Samsung	[3] DISPLAY
LG	[4] SW ⏵ +
Panasonic	[17] TV PROG -
Philips	[5] CLEARAUDIO+ [5] MOVIE [5] GAME
Sharp	[4] SW ⏵ -
Toshiba	[5] STANDARD

- 2 Keep holding the TV I/⏻ (on/standby) button and press the ⊕ (enter) button.
- 3 Release the TV I/⏻ (on/standby) button on the remote control of the system pressed.

Specifications

Bar Speaker (SA-CT370, SA-CT770)

Amplifier section

POWER OUTPUT (rated)

Front L + Front R: 50 W + 50 W
(at 4 ohms, 1 kHz, 1% THD)

POWER OUTPUT (reference)

SA-CT370:

Front L/Front R: 100 Watts (per channel at 4 ohms, 1 kHz)

SA-CT770:

Front L/Front R: 105 Watts (per channel at 4 ohms, 1 kHz)

Inputs

HDMI IN 1/2/3*

ANALOG IN

DIGITAL IN (OPT (TV))

* These 3 jacks are identical. Using any of them makes no difference.

Output

HDMI OUT (TV (ARC))

BLUETOOTH section

Communication system

BLUETOOTH Specification version 3.0

Output

BLUETOOTH Specification Power Class 2

Maximum communication range

Line of sight approx. 10 m¹⁾

Maximum number of devices to be registered

9 devices

Frequency band

2.4 GHz band (2.4000 GHz - 2.4835 GHz)

Modulation method

FHSS (Freq Hopping Spread Spectrum)

Compatible BLUETOOTH profiles²⁾

A2DP (Advanced Audio Distribution Profile)

AVRCP 1.3 (Audio Video Remote Control Profile)

Supported Codex³⁾

SBC⁴⁾, AAC⁵⁾

Transmission range (A2DP)

20 Hz - 20,000 Hz (Sampling frequency 44.1 kHz)

- 1) The actual range will vary depending on factors such as obstacles between devices, magnetic fields around a microwave oven, static electricity, cordless phone, reception sensitivity, operating system, software application, etc.
- 2) BLUETOOTH standard profiles indicate the purpose of BLUETOOTH communication between devices.
- 3) Codec: Audio signal compression and conversion format
- 4) Subband Codec
- 5) Advanced Audio Coding

Front L/Front R speaker section

Speaker system

SA-CT370: Full-range speaker system, Acoustic suspension

SA-CT770: 2-way speaker system, Acoustic suspension

Speaker

SA-CT370: 60 mm cone type

SA-CT770: 60 mm cone type woofer

20 mm balance drive tweeter

Rated impedance

4 ohms

General

Power requirements

220 V - 240 V AC, 50 Hz/60 Hz

Power consumption

On: 34 W

Standby mode (Control for HDMI is set to on): 0.5 W or less

Standby mode (Control for HDMI is set to off): 0.3 W or less

BLUETOOTH Standby mode: 0.5 W or less

Dimensions (approx.) (w/h/d)

SA-CT370:

900 mm × 50 mm × 113 mm
(without wall mounting brackets)

900 mm × 113 mm × 72 mm
(with wall mounting brackets)

SA-CT770:

1030 mm × 50 mm × 113 mm
(without wall mounting brackets)

1030 mm × 113 mm × 72 mm
(with wall mounting brackets)

Mass (approx.)

SA-CT370: 2.4 kg

SA-CT770: 2.6 kg

Dimensions (approx.) (w/h/d)

SA-WCT370: 135 mm × 361.5 mm × 394 mm (vertical)
361.5 mm × 135 mm × 394 mm (horizontal)

SA-WCT770: 271 mm × 404 mm × 271 mm

Mass (approx.)

SA-WCT370: 7.0 kg

SA-WCT770: 8.8 kg

Wireless transmitter/receiver section

Speaker system

Wireless Sound Specification version 2.0

Frequency band

2.4 GHz (2.4000 GHz - 2.4835 GHz)

Modulation method

π / 4 DQPSK

Digital audio input formats supported by the system

Dolby Digital

DTS-HD Master Audio*

Dolby Digital Plus*

DTS-HD High Resolution Audio*

Dolby TrueHD*

DTS-HD Low Bit Rate*

DTS

Linear PCM 2ch 48 kHz or less

DTS 96/24

Linear PCM Maximum 7.1ch 192 kHz or less*

* It is possible to input these formats only with HDMI connection.

Subwoofer (SA-WCT370, SA-WCT770)

POWER OUTPUT (reference)

SA-WCT370: 100 W (per channel at 4 ohms, 100 Hz)

SA-WCT770: 120 W (per channel at 4 ohms, 100 Hz)

Speaker system

Subwoofer system, Bass reflex

Speaker

SA-WCT370: 100 mm × 150 mm cone type

SA-WCT770: 160 mm cone type

Rated impedance

4 ohms

Power requirements

220 V - 240 V AC, 50 Hz/60 Hz

Power consumption

On: 30 W

Standby mode: 0.5 W or less

Video formats supported by the system

Input/Output (HDMI Repeater block)

File	2D	3D		
		Frame packing	Side-by-Side (Half)	Over-Under (Top-and-Bottom)
4096 × 2160p @ 59.94/60 Hz ^{*1}	○	-	-	-
4096 × 2160p @ 50 Hz ^{*1}	○	-	-	-
4096 × 2160p @ 23.98/24 Hz ^{*2}	○	-	-	-
3840 × 2160p @ 59.94/60 Hz ^{*1}	○	-	-	-
3840 × 2160p @ 50 Hz ^{*1}	○	-	-	-
3840 × 2160p @ 29.97/30 Hz ^{*2}	○	-	-	-
3840 × 2160p @ 25 Hz ^{*2}	○	-	-	-
3840 × 2160p @ 23.98/24 Hz ^{*2}	○	-	-	-
1920 × 1080p @ 59.94/60 Hz	○	-	○	○
1920 × 1080p @ 50 Hz	○	-	○	○
1920 × 1080p @ 29.97/30 Hz	○	○	○	○
1920 × 1080p @ 25 Hz	○	○	○	○
1920 × 1080p @ 23.98/24 Hz	○	○	○	○
1920 × 1080i @ 59.94/60 Hz	○	○	○	○
1920 × 1080i @ 50 Hz	○	○	○	○
1280 × 720p @ 59.94/60 Hz	○	○	○	○
1280 × 720p @ 50 Hz	○	○	○	○
1280 × 720p @ 29.97/30 Hz	○	○	○	○
1280 × 720p @ 23.98/24 Hz	○	○	○	○
720 × 480p @ 59.94/60 Hz	○	-	-	-
720 × 576p @ 50 Hz	○	-	-	-
640 × 480p @ 59.94/60 Hz	○	-	-	-

^{*1} YCbCr 4:2:0/Supported 8-bit only

^{*2} Supported 8-bit only

Design and specifications are subject to change without notice.

HDMI

<http://www.sony.net/>

©2014 Sony Corporation Printed in China



* 4 4 8 8 9 7 0 2 1 * (3)

4-488-970-21(3)