

SONY®

4-748-702-11(1)



Television

Reference Guide



Customer Support and Contact:

<http://www.sony-asia.com/support>

BRAVIA

OLED

KD-65A9G / 55A9G

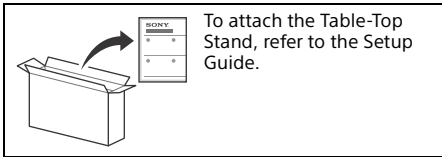

Table of Contents

Safety Information	2
Protecting the TV Screen (OLED TV)	4
Parts and Controls	5
Controls and Indicators	5
Using Remote Control	6
Remote Control Parts Description	6
Connection Diagram	8
Installing the TV to the Wall	10
Using the optional Wall-Mount Bracket	10
Troubleshooting	12
Troubles and Solutions	12
Specifications	13

Introduction

Thank you for choosing this Sony product. Before operating the TV, please read this manual thoroughly and retain it for future reference.

Note

- Before operating the TV, please read the “Safety Information” (page 2).
- Read the supplied Safety Information for additional safety information.
- Instructions about “Installing the TV to the Wall” are included within this TV’s instruction manual.
- Images and illustrations used in the Setup Guide and this manual are for reference only and may differ from the actual product.

Help

Find more troubleshooting and other useful information directly from your TV. Press **HELP** on the remote control to display a list of topics, or to search by keyword.

Help Guide (Manual)

For more detailed information, select [Help Guide] from the Help menu on your TV. You can also check the Help Guide from your PC or smartphone (information provided on the back cover of this manual).

Location of the identification label

Labels for the TV Model No. and Power Supply rating are located on the rear of the TV. They can be found by removing the stand cover **(CD1)**.

Safety Information

Installation/Set-up

Install and use the TV set in accordance with the instructions below in order to avoid any risk of fire, electric shock or damage and/or injuries.

Installation

- The TV set should be installed near an easily accessible AC power outlet (mains socket).
- Place the TV set on a stable, level surface to prevent it from falling over and causing personal injury or property damage.
- Install the TV where it cannot be pulled, pushed, or knocked over.
- Install the TV so that the TV’s Table-Top Stand does not protrude out from the TV stand (not supplied). If the TV’s Table-Top Stand protrudes out from the TV stand, it may cause TV set to topple over, fall down, and cause personal injury or damage to the TV.

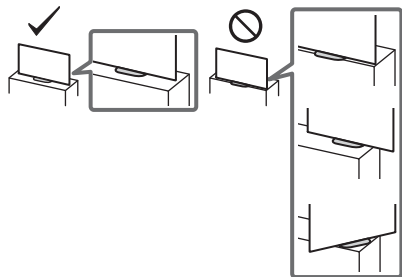

- For safety reasons, be sure to attach the center covers to the rear of the TV when TV in Table-Top condition.
 - Only qualified service personnel should carry out wall-mount installations.
 - For safety reasons, it is strongly recommended that you use Sony accessories, including:
 - Wall-Mount Bracket SU-WL450
 - Be sure to use the screws supplied with the Wall-Mount Bracket when attaching the Wall-Mount Bracket to the TV set. The supplied screws are designed as indicated by illustration when measured from the attaching surface of the Wall-Mount Bracket. The diameter and length of the screws differ depending on the Wall-Mount Bracket model.
- Use of screws other than those supplied may result in internal damage to the TV set or cause it to fall, etc.

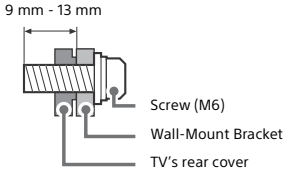

Transporting

- Before transporting the TV set, disconnect all cables.
 - Two or three people are needed to transport a large TV set.
 - When transporting the TV set by hand, hold it as shown below.
- Do not put stress on the panel and the frame around the screen.

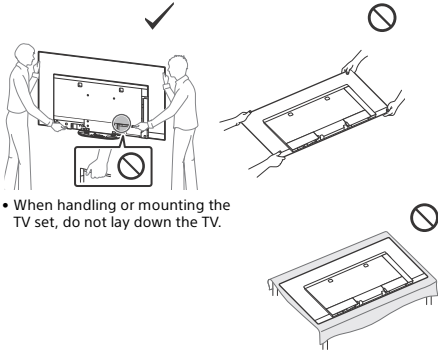

- When handling or mounting the TV set, do not lay down the TV.

- When transporting the TV set, do not subject it to jolts or excessive vibration.
- When transporting the TV set for repairs or when moving, pack it using the original carton and packing material.

Topple prevention

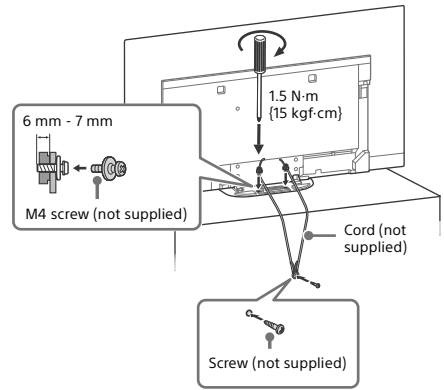

Ventilation

- Never cover the ventilation holes or insert anything into the cabinet.
- Leave space around the TV set as shown below.
- It is strongly recommended that you use a Sony Wall-Mount Bracket in order to provide adequate air circulation.

Installed on the wall

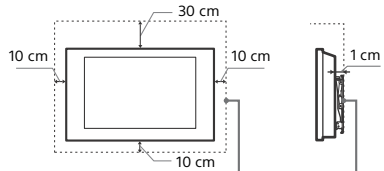

Leave at least this much space around the set.

Installed with stand

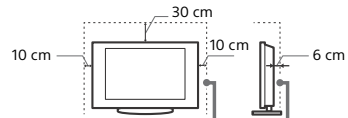

Leave at least this space around the set.

- To ensure proper ventilation and prevent the collection of dirt or dust:
 - Do not lay the TV set flat, install upside down, backwards, or sideways.
 - Do not place the TV set on a shelf, rug, bed or in a closet.
 - Do not cover the TV set with a cloth, such as curtains, or items such as newspapers, etc.

– Do not install the TV set as shown below.

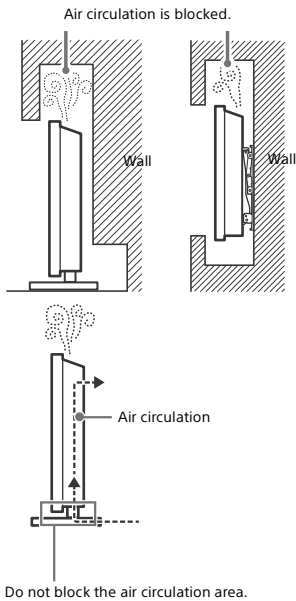

This receiver complies with the minimum requirements as specified in National Telecommunications Commission, Memorandum Circular 02-03-2016, Regarding the Sale and Labeling of ISDB-T Receivers, including Memorandum Circular No. 01-0302017, Amending Certain Provisions of Section 2 of NTC Memorandum Circular No. 02-03-2016 (Sale and Labeling of ISDB-T Receivers).

Protecting the TV Screen (OLED TV)

Precautions to Protect the Screen from Damage

Image retention

OLED TV's are susceptible to image retention (burn-in) due to the characteristics of the materials used. Image retention may occur if images are displayed in the same location on the screen repeatedly or over extended periods of time. This is not a malfunction of the TV. Avoid displaying images that may cause image retention.

The following are examples of images that may cause image retention:

- Content with black bars either on the top and bottom and/or the left and right sides of the screen. (for example, Letterboxed, 4:3 screen, Standard definition)
- Static images such as photos.
- Video games that might have static content in some part of the screen.
- On-screen menus, program guides, channel logos etc.
- Static content from applications.
- On-screen tickers, such as those used for news and headlines.

To reduce the risk of image retention:

- Sony recommends that you turn off the TV normally by pressing the power button on the remote control or the TV.
- Fill the screen by changing [Wide mode] to eliminate the black bars. Select [Wide mode] other than [Normal].
- Turn off the OSD (On Screen Display) by pressing the **[I+/?]** button, and turn off the menus from connected equipment. For details, refer to the instruction manuals for the connected equipment.
- Avoid displaying static images with bright colors (including white), clocks or logos on any portion of the screen.
- Set the picture settings based on the ambient conditions. The Standard Picture is recommended for home use and when viewing content that often displays the station logos, etc.

The TV has following features to help reduce/prevent image retention.

Panel refresh

Panel refresh will automatically run to adjust the uniformity of the TV screen after it has been in use for long periods of time. Panel refresh can also be performed manually and should only be used if image retention is very noticeable or you see the following message: [Panel refresh did not finish...]

Caution:

- The Panel refresh function may affect the panel. As a reference, perform the Panel refresh only once a year, do not perform it more than once a year as it may affect the usable life of the panel.
- Panel refresh takes about one hour to complete.
- A white line may be displayed on the screen during the Panel refresh, this is not a malfunction of the TV.
- Panel refresh will only work when the room temperature is between 10 °C and 40 °C.

Pixel shift

Automatically moves the image on the screen to prevent image retention.

Other feature

The screen brightness is automatically reduced when displaying still images, clocks, bright colors or logos etc.

Parts and Controls

Controls and Indicators

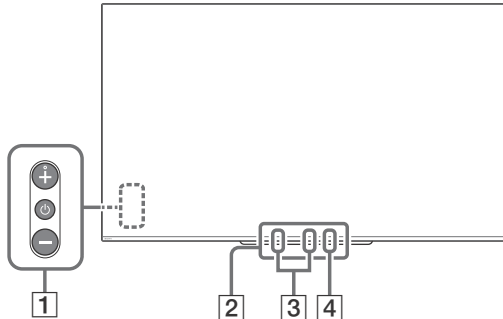

1 **⏻ (Power) / + / -**

When the TV is off,
Press **⏻** to power on.

When the TV is on,
Press and hold **⏻** to power off.
Press **⏻** repeatedly to change the function,
then press **+** or **-** button to:

- Adjust the volume.
- Select the channel.
- Select the input source of TV.

2 **Remote Control sensor*1 / Light sensor*1 / Illumination LED**

The illumination LED lights up or blinks according to the status of the TV.
For more information, refer to the Help Guide.

3 **Built-in MIC*2*3**

Use the hands-free built-in microphone for voice search. To enable the built-in MIC, follow the on-screen instructions when you press the **🗨** button.

4 **Built-in MIC LED**

The built-in MIC LED lights up in amber when the built-in MIC is enabled. The built-in MIC LED can be disabled.*3

*1 Do not place anything near the sensor.

*2 The voice search requires an Internet connection. The voice search with the built-in MIC is available only on limited region/country/language. Standby power consumption will increase because the built-in MIC is always listening when the voice search with the built-in MIC is enabled.



*3 For more information, see the Online Help Guide (page 2).

Using Remote Control

Remote Control Parts Description

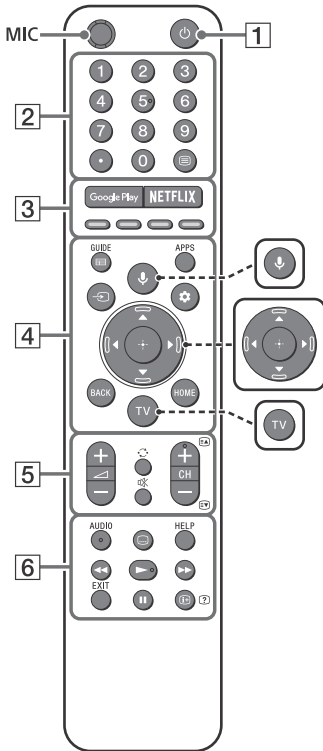
The remote control shape, location, availability and function of remote control buttons may vary depending on your region/country/TV model.



-  **🗣️ (Microphone)**
Use voice search*. (e.g., Search various content by voice.)
-  **▲/▼/◀/▶/⊕ (Navigation D-Pad)**
On screen menu navigation and selection.
-  **TV**
Switch to a TV channel or input and display the TV menu.

* The voice search requires an Internet connection.

1  **(TV standby)**
Turn on or turn off the TV (standby mode).

2 **Number buttons**

Use with the 0-9 buttons to select digital channels.

 **(Text)**
Display text information.

3 **Google Play**
Access the “Google Play” online service.

NETFLIX (Only on limited region/country/TV model)
Access the “NETFLIX” online service.

Color buttons
Execute corresponding function at that time.

4 **GUIDE**

Display the digital program guide.

APPS

Display a list of installed apps.

(Input select)

Display and select the input source, etc.

(Quick settings)

Display Quick Settings.

BACK

Return to the previous screen.

HOME

Display the TV Home Menu.

5 +/- **(Volume)**

Adjust the volume.

(Jump)

Jump back and forth between two channels or inputs. The TV alternates between the current channel or input and the last channel or input that was selected.

(Mute)



Mute the sound. Press again to restore the sound.

Hint

- The accessibility shortcut service can be turned on or off by pressing and holding .

CH +/-

In TV mode: Select the channel.

In Text mode: Select the next () or previous () page.

6 **AUDIO**

Select the sound of multilingual source or dual sound for the program currently being viewed (depend on program source).

(Subtitle setting)

Turn subtitles on or off (when the feature is available).

HELP

Display the Help menu. Help Guide can be accessed from here.

Operate media contents on the TV and connected BRAVIA Sync-compatible device.

EXIT

Return to the previous screen or exit from the menu. When an Interactive Application service is available, press to exit from the service.

(Info/Text reveal)

Display information.

Connection Diagram

For more information on connections, refer to the Help Guide by pressing **HELP** on the remote control.

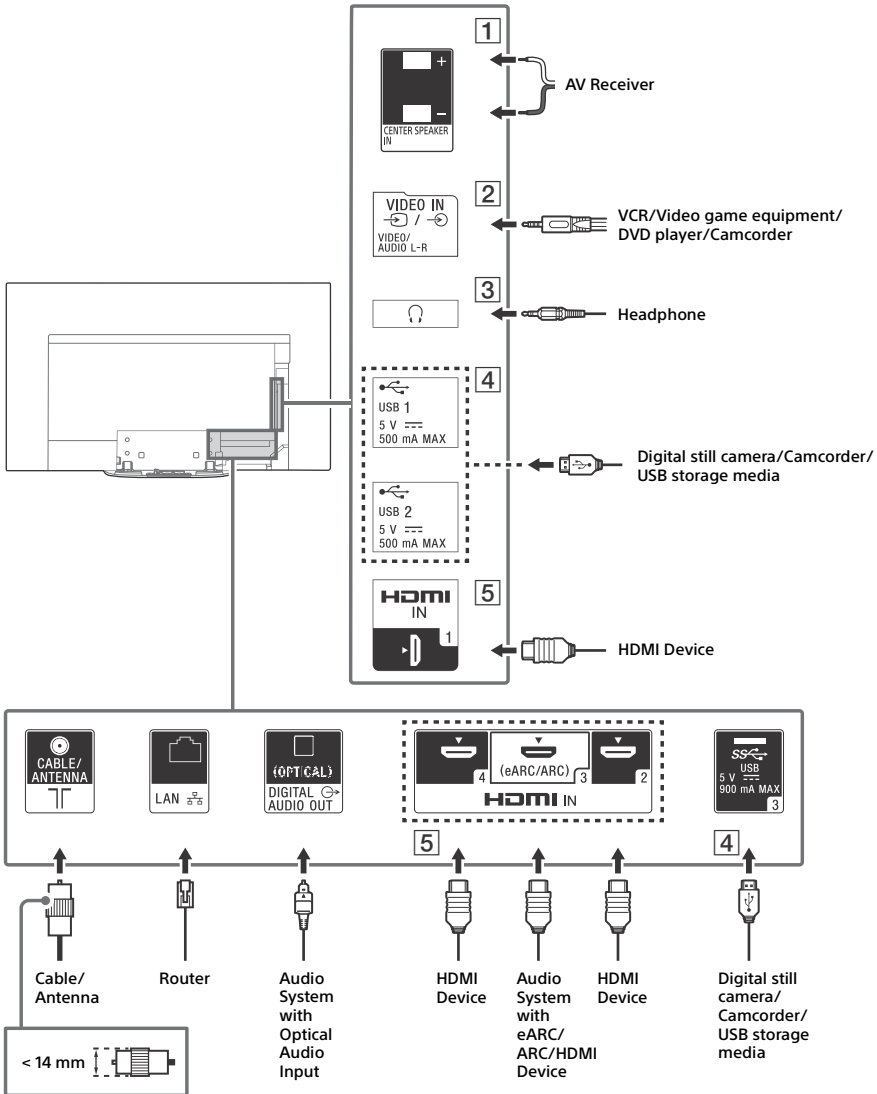

1 CENTER SPEAKER IN

- To use your TV speakers as the center speaker, connect the output of your AV receiver to the CENTER SPEAKER IN on your TV.
- Before connecting cables, disconnect the AC power cord (mains lead) of both TV and AV receiver.
- Make sure the [Speakers] is set to [Audio system].

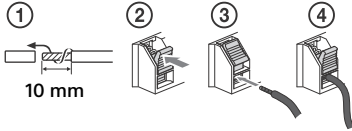

To prevent hiss when not connecting the CENTER SPEAKER IN to an AV receiver, disable [TV center speaker mode]. For details, refer to the Help Guide.

2 VIDEO IN

- For a composite connection, use an Analog Extension Cable (not supplied).
-

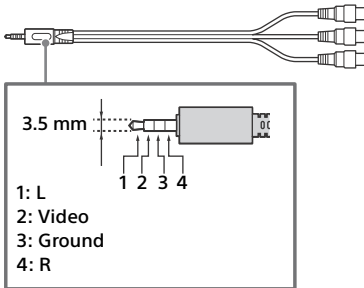

3 (Headphone)

- Supports 3-pole stereo mini jack only.
- You cannot output sound from both the headphone and the TV speakers at the same time.

4 USB 1/2, USB 3

- Connecting a large USB device may interfere with other connected devices beside it.
- When connecting a large USB device, connect to the USB 1 port.

5 HDMI IN 1/2/3/4

- HDMI interface can transfer the digital video and audio on a single cable.

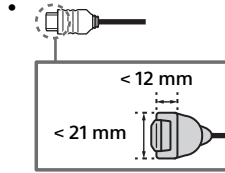

- To enjoy high quality 4K 50p/60p contents, connect a Premium High Speed HDMI cable and set the [HDMI signal format] to [Enhanced format]. Do this setting individually for each connected HDMI IN terminal. For details of supported formats, refer to the "Specifications" in this manual (page 13-14).
- **HDMI IN 3 eARC/ARC (Enhanced Audio Return Channel/Audio Return Channel)**
Connect your audio system to the HDMI IN 3 to route TV audio to your audio system. An audio system that supports HDMI eARC/ARC can send video to the TV, and receive audio from the TV via the same HDMI cable. If your audio system does not support HDMI eARC/ARC, an additional connection with DIGITAL AUDIO OUT (OPTICAL) is necessary.
- Use the HDMI cable with Ethernet to connect audio system with eARC.



Note

- You cannot attach the side cover (CC) while the cables are connected to side terminal.
- Be sure to store the side cover in a safe place for future use.

Installing the TV to the Wall

Using the optional Wall-Mount Bracket

To Customers:

For product protection and safety reasons, Sony strongly recommends that installation of your TV be performed by Sony dealers or licensed contractors. Do not attempt to install it yourself.

To Sony Dealers and Contractors:

Provide full attention to safety during the installation, periodic maintenance and examination of this product.

Wall-Mount Bracket Installation Information

This TV's instruction manual only provides the steps to prepare the TV for Wall-Mount installation before it is installed on the wall.

For instructions on Wall-Mount Bracket installation, see the Installation Information (Wall-Mount Bracket) on the product page for your TV model.

<http://www.sony-asia.com/support>

Preparing for Wall-Mount Installation

Use the Wall-Mount Bracket SU-WL450 (not supplied) to install the TV to the wall.

Make sure to attach the Table-Top Stand before installing the TV to the wall by referring to the Setup Guide.

- Prepare the TV for the Wall-Mount Bracket before making cable connections.
- Follow the instruction guide provided with the Wall-Mount Bracket for your model. Sufficient expertise is required in installing this TV, especially to determine the strength of the wall for withstanding the TV's weight.
- Be sure to entrust the attachment of this product to the wall to Sony dealers or licensed contractors and pay adequate attention to safety during the installation. Sony is not liable for any damage or injury caused by mishandling or improper installation.
- The screws for Wall-Mount Bracket are not supplied.
- Be sure to store the unused screws and Table-Top Stand in a safe place until you are ready to attach the Table-Top Stand. Keep the screws away from small children.

1 Remove the stand cover and terminal covers.

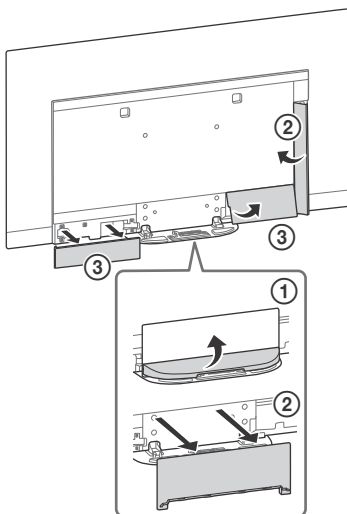

2 Remove the screws from the rear of the TV.

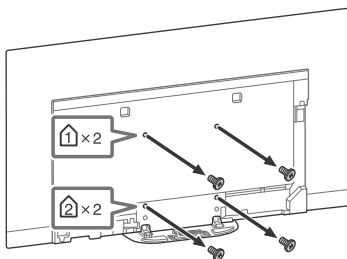

Troubleshooting

General troubleshooting for issues like: black screen, no sound, frozen picture, TV does not respond, or network is lost, do the following steps.

- 1 Restart your TV by pressing the power button on the remote control until a message appears. The TV will restart. If the TV does not recover, try unplugging the AC power cord (mains lead). Then press the power button on the TV and wait for two minutes, and plug in the AC power cord (mains lead).
- 2 Refer to the Help menu by pressing **HELP** on the remote control.
- 3 Connect your TV to the Internet and perform a software update. Sony recommends you to keep your TV software updated. Software updates provide new features and performance improvements.
- 4 Visit Sony support website (information provided on the front cover of this manual).

When you plug in the TV, the TV may not be able to turn on for a while even if you press the power button on the remote control or the TV.

It takes time to initialize the system. Wait for about one minute, then operate it again.

Troubles and Solutions

When the illumination LED is flashing in red.

- Count how many times it flashes (interval time is three seconds).
Reboot the TV by disconnecting the AC power cord (mains lead) until the illumination LED stopped flashing in red, then turn on the TV.
If the problem persists, disconnect the AC power cord (mains lead), and contact your dealer or Sony service center with the number of times the illumination LED flashes.

There is no picture (screen is dark) and no sound.

- Check the antenna/cable connection.
- Connect the TV to the AC power (mains), and press the power button on the TV or the remote control.

Some programs cannot be tuned.

- Check the antenna/cable connection.

The remote control does not function.

- Replace the batteries.

The parental lock for broadcast password has been forgotten.

- Enter 4357 for the password and select [Change password].

The TV surrounds become warm.

- When the TV is used for an extended period, the TV surrounds become warm. You may feel hot when touching there by the hand.

The screen becomes darker while watching TV.

- If the whole image or part of the image remains still, the screen brightness will be gradually reduced to prevent image retention. This is not a malfunction of the TV.

You are concerned about image retention.

If the same image is displayed repeatedly or for long periods of time, image retention may occur. To reduce image retention, we recommend that you turn off the TV normally by pressing the power button on the remote control or the TV.

Note

- Perform Panel refresh manually only when image retention is particularly noticeable. As a reference, perform it only once a year. Avoid performing it more than once a year because it may affect the usable life of the panel.
- Images that include clocks, logos and bright colors (including white) easily cause image retention. Avoid displaying these types of images for long periods of time, otherwise image retention may occur.

A white line appears on the screen.

- Panel refresh automatically runs after the TV has been used for long periods of time to reduce image retention. Panel refresh starts after the TV is turned off and takes about one hour to complete. A white line may be displayed on the screen during the Panel refresh. This is not a malfunction of the TV.

The message [Panel refresh did not finish...] is displayed.

Panel refresh automatically runs after the TV has been used for long periods of time to reduce image retention. If the TV is turned on, the AC power cord (mains lead) is unplugged, or the room temperature falls outside of the range between 10 °C and 40 °C during the Panel refresh, the process will not be completed and this message will appear.

- If Panel refresh started automatically, it will restart when you turn off the TV with the remote control.
- If Panel refresh initiated manually, you must select it again.

Specifications

System

Panel system

OLED (Organic Light Emitting Diode) Panel

TV system

Analog: M

Digital: ISDB-T

Color system

NTSC/PAL N(Video Only)/PAL M(Video Only)

Channel coverage

Analog: UHF/VHF/Cable

Digital: UHF/VHF

Sound output

20 W + 20 W + 10 W + 10 W

Wireless technology

Protocol IEEE802.11ac/a/b/g/n

Bluetooth Version 4.2

Input/Output jacks

Antenna/cable

75 ohm external terminal for VHF/UHF

 /  VIDEO IN

Video/Audio input (mini jack)

HDMI IN 1/2/3/4 (support 4K resolution, HDCP 2.3-compatible)

Video:

4096 × 2160p (50, 60 Hz)^{*1+2}, 4096 × 2160p (24 Hz)^{*1}, 3840 × 2160p (50, 60 Hz)^{*2}, 3840 × 2160p (24, 25, 30 Hz), 1080p (30, 50, 60, 100, 120 Hz), 1080/24p, 1080i (50, 60 Hz), 720p (30, 50, 60 Hz), 720/24p, 576p, 480p, PC Formats^{*3}

Audio:

In eARC (Enhanced Audio Return Channel) mode^{*4}

Refer to the Help Guide for details.

Except eARC mode

5.1 channel linear PCM: 32/44.1/48/88.2/96/176.4/192 kHz 16/20/24 bits, Dolby Digital, Dolby Digital Plus, DTS

eARC/ARC (Enhanced Audio Return Channel/Audio Return Channel) (HDMI IN 3 only)

In eARC mode^{*4}

Refer to the Help Guide for details.

In ARC mode

Two channel linear PCM: 48 kHz 16 bits, Dolby Digital, Dolby Digital Plus, DTS

 DIGITAL AUDIO OUT (OPTICAL)

Digital optical jack (Two channel linear PCM: 48 kHz 16 bits, Dolby Digital, DTS)

 (Stereo mini jack)

Headphone

• 1, • 2, **SS** 3

USB port 1 and 2 support High Speed USB (USB 2.0)

USB port 3 supports Super Speed USB (USB 3.1 Gen 1)

LAN

10BASE-T/100BASE-TX connector (Depending on the operating environment of the network, connection speed may differ. The communication rate and quality are not guaranteed.)

CENTER SPEAKER IN

Center speaker input terminal

Others

Optional accessories

Wall-Mount Bracket: SU-WL450

Operating temperature

0 °C – 40 °C

Power and others

Power requirements

110 V - 240 V AC, 50/60 Hz

Screen size (measured diagonally) (Approx.)

KD-65A9G: 65 inches / 163.9 cm

KD-55A9G: 55 inches / 138.8 cm

Power consumption

KD-65A9G: 469 W

KD-55A9G: 373 W

Standby power consumption*5*6

0.5 W

Display resolution

3,840 pixels (horizontal) × 2,160 lines (vertical)

Output Rating

USB 1/2

5 V $\overline{=}$, 500 mA MAX

USB 3

5 V $\overline{=}$, 900 mA MAX

Dimensions (Approx.) (w × h × d)

with Table-Top Stand

KD-65A9G: 1,447 × 838 × 255 mm

KD-55A9G: 1,226 × 714 × 255 mm

without Table-Top Stand

KD-65A9G: 1,447 × 834 × 40 mm

KD-55A9G: 1,226 × 710 × 40 mm

Mass (Approx.)

with Table-Top Stand

KD-65A9G: 24.8 kg

KD-55A9G: 22.3 kg

without Table-Top Stand

KD-65A9G: 21.2 kg

KD-55A9G: 18.7 kg

*1 When 4096 × 2160p is input and [Wide mode] is set to [Normal], the resolution is displayed as 3840 × 2160p. To display 4096 × 2160p, set [Wide mode] setting to [Full 1] or [Full 2].

*2 To support 18 Gbps, set [HDMI signal format] to [Enhanced format].

*3 Refer to the Help Guide for details.

*4 eARC mode is active when [eARC mode] is set to [Auto], [Speakers] is set to [AUDIO system] and eARC compatible audio system is connected.

*5 Specified standby power is reached after the TV finishes necessary internal processes.

*6 Standby power consumption will increase when your TV is connected to the network.

Note

- Optional accessories availability depends on countries/region/TV model/stock.
- Design and specifications are subject to change without notice.

Trademark Information

- The terms HDMI and HDMI High-Definition Multimedia Interface, and the HDMI Logo are trademarks or registered trademarks of HDMI Licensing Administrator, Inc. in the United States and other countries.
- Dolby, Dolby Vision, Dolby Audio, and the double-D symbol are trademarks of Dolby Laboratories. Manufactured under license from Dolby Laboratories. Confidential unpublished works. Copyright ©1992-2015 Dolby Laboratories. All rights reserved.
- "BRAVIA", BRAVIA and BRAVIA Sync are trademarks or registered marks of Sony Corporation.
- Gracenote, the Gracenote logo and logotype, "Powered by Gracenote" logo are either registered trademarks or trademarks of Gracenote, Inc. in the United States and/or other countries.
- Vewd® Core. Copyright 1995-2019 Vewd Software AS. All rights reserved.
- Google, Google Play, Chromecast, YouTube, Android TV and other related marks and logos are trademarks of Google LLC.
- Wi-Fi®, Wi-Fi Alliance® and Wi-Fi Direct® are registered trademarks of Wi-Fi Alliance.
- The Wi-Fi CERTIFIED™ Logo is a certification mark of Wi-Fi Alliance.
- For DTS patents, see <http://patents.dts.com>. Manufactured under license from DTS, Inc. DTS, the Symbol, & DTS and the Symbol together are registered trademarks, and DTS Digital Surround is a trademark of DTS, Inc. © DTS, Inc. All Rights Reserved.

- The Bluetooth® word mark and logos are registered trademarks owned by the Bluetooth SIG, Inc. and any use of such marks by Sony Corporation is under license. Other trademarks and trade names are those of their respective owners.
- Netflix is a registered trademark of Netflix, Inc.
- TUXERA is a registered trademark of Tuxera Inc. in the US and other countries.
- USB-IF SuperSpeed USB Trident logo is a registered trademark of USB Implementers Forum, Inc. . The logo consists of the letters 'SS' in a bold, sans-serif font, followed by a stylized trident symbol with a horizontal line extending to the right, ending in an arrowhead.
- All other trademarks are the property of their respective owners.



Help Guide

http://rd1.sony.net/help/tv/gusltn2/h_usltn/

<http://www.sony.net/>

© 2019 Sony Visual Products Inc. Printed in Malaysia